

## MOSFET

180 Amps, 100 Volts N-CHANNEL MOSFET

### FEATURE

- ◆ Low gate charge
- ◆ Low Ciss
- ◆ Fast switching
- ◆ 100% avalanche tested
- ◆ Improved dv/dt capability
- ◆ RoHS 2.0 Compliant

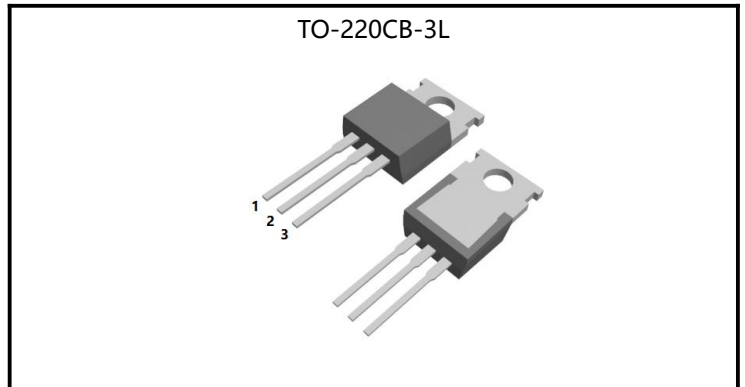

Parameter	Values	Unit
Bvdss	100	V
Id	180	A
Rdson(max)	2.7	mΩ

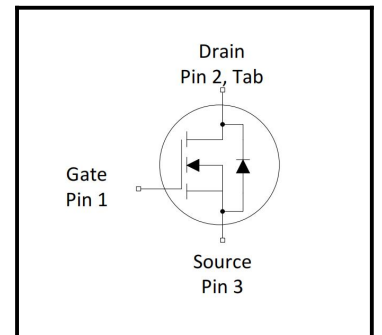

Ordering Code	Marking	Package	Packaging
PW027N10CS	PW027N10CS	TO-220CB-3L	Tube

## Absolute Maximum Ratings( $T_C=25^{\circ}\text{C}$ , unless otherwise noted)

Parameter	Symbol	Values			Unit	Note/Test Conditions
		Min	Typ	Max		
Drain-Source Voltage	$V_{DSS}$	-	-	100	V	-
Gate-Source Voltage	$V_{GS}$	-20	-	20	V	-
Continuous Drain Current(Package Limited)	$I_D$	-	-	180	A	$T_C=25^{\circ}\text{C}$
		-	-	84	A	$T_C=100^{\circ}\text{C}$
Pulsed Drain Current(Note1)	$I_{DM}$	-	-	720	A	-
Single Pulse Avalanche Energy	$E_{AS}$	-	-	441	mJ	$L=0.5\text{mH}, V_D=50\text{V}, T_C=25^{\circ}\text{C}$
Maximum Power Dissipation	$P_D$	-	-	227	W	$T_C=25^{\circ}\text{C}$
Operating Junction and Storage Temperature Range	$T_J, T_{STG}$	-55	-	150	$^{\circ}\text{C}$	-
Maximum lead temperature for soldering purposes, 1/8"from case for 5 seconds	$T_L$	-	-	260	$^{\circ}\text{C}$	-

## Thermal Characteristics

Parameter	Symbol	Values			Unit	Note/Test Conditions
		Min	Typ	Max		
Thermal resistance , Channel to Case	$R_{th(ch-c)}$	-	-	0.55	$^{\circ}\text{C}/\text{W}$	-

## Electrical Characteristics ( $T_C=25^{\circ}\text{C}$ , unless otherwise noted)

### Static characteristics

Parameter	Symbol	Values			Unit	Note/Test Conditions
		Min	Typ	Max		
Drain-Source Breakdown Voltage	$BV_{DSS}$	100	-	-	V	$V_{GS}=0\text{V}, I_D=250\mu\text{A}$
Zero Gate Voltage Drain Current	$I_{DSS}$	-	-	1	$\mu\text{A}$	$V_{DS}=100\text{V}, V_{GS}=0\text{V}$
Gate-Body Leakage Current, Forward	$I_{GSSF}$	-	-	100	nA	$V_{GS}=20\text{V}, V_{DS}=0\text{V}$
Gate-Body Leakage Current, Reverse	$I_{GSSR}$	-	-	-100	nA	$V_{GS}=-20\text{V}, V_{DS}=0\text{V}$
Gate-Source Threshold Voltage	$V_{GS(th)}$	2.0	-	4.0	V	$V_{DS}=V_{GS}, I_D=250\mu\text{A}$
Drain-Source On-State Resistance	$R_{DS(on)}$	-	2.1	2.7	$\text{m}\Omega$	$V_{GS}=10\text{V}, I_D=20\text{A}$
Gate Resistance	$R_g$	-	1.4	-	$\Omega$	$V_{GS}=0\text{V}, V_{DS}$ Open, $f=1\text{MHz}$
Forward Transconductance	$g_{fs}$	-	17	-	S	$V_{DS}=5\text{V}, I_D=20\text{A}$



## Dynamic characteristics

Parameter	Symbol	Values			Unit	Note/Test Conditions
		Min	Typ	Max		
Input Capacitance	$C_{iss}$	-	15020	-	pF	$V_{DS}=25V, V_{GS}=0V, f=1.0MHz$
Output Capacitance	$C_{oss}$	-	4221	-	pF	$V_{DS}=25V, V_{GS}=0V, f=1.0MHz$
Reverse Transfer Capacitance	$C_{rss}$	-	98	-	pF	$V_{DS}=25V, V_{GS}=0V, f=1.0MHz$
Turn-On Delay Time	$t_{d(on)}$	-	34	-	ns	$V_{DD}=50V, R_G=3\Omega, V_{GS}=10V, I_D=10A$
Turn-On Rise Time	$t_r$	-	26	-	ns	$V_{DD}=50V, R_G=3\Omega, V_{GS}=10V, I_D=10A$
Turn-Off Delay Time	$t_{d(off)}$	-	78	-	ns	$V_{DD}=50V, R_G=3\Omega, V_{GS}=10V, I_D=10A$
Turn-Off Fall Time	$t_f$	-	30	-	ns	$V_{DD}=50V, R_G=3\Omega, V_{GS}=10V, I_D=10A$

## Gate charge characteristics

Parameter	Symbol	Values			Unit	Note/Test Conditions
		Min	Typ	Max		
Total Gate Charge	$Q_g$	-	237.7	-	nC	$V_{DS}=80V, I_D=20A, V_{GS}=10V$
Gate-Source Charge	$Q_{gs}$	-	74.1	-	nC	$V_{DS}=80V, I_D=20A, V_{GS}=10V$
Gate-Drain Charge	$Q_{gd}$	-	44.7	-	nC	$V_{DS}=80V, I_D=20A, V_{GS}=10V$

## Reverse diode

Parameter	Symbol	Values			Unit	Note/Test Conditions
		Min	Typ	Max		
Continuous Diode Forward Current	$I_S$	-	-	180	A	-
Pulsed Diode Forward Current	$I_{SM}$	-	-	720	A	-
Diode Forward Voltage	$V_{SD}$	-	-	1.2	V	$I_S=20A, V_{GS}=0V$
Reverse Recovery Time	$t_{rr}$	-	127	-	ns	$V_D=30V, I_F=1A$
Reverse Recovery Charge	$Q_{rr}$	-	320	-	nC	$di/dt=100A/\mu s, (Note2)$

## Notes

1. Repetitive Rating:pulse width limited by maximum junction temperature.
2. Pulse width $\leq 300\mu s$ ,duty cycle $\leq 2\%$ .

RATING AND CHARACTERISTIC CURVES

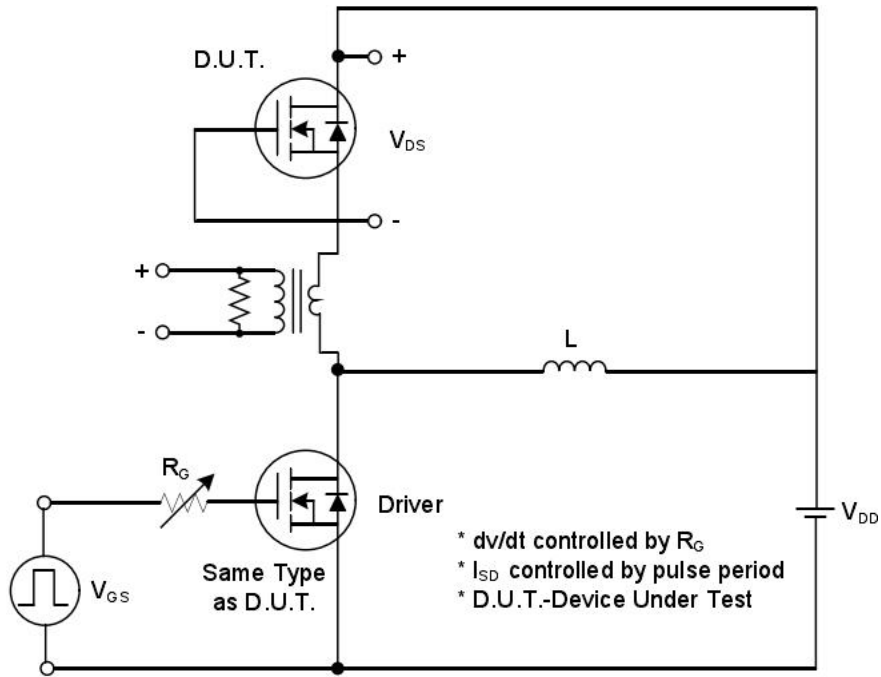

Peak Diode Recovery dv/dt Test Circuit

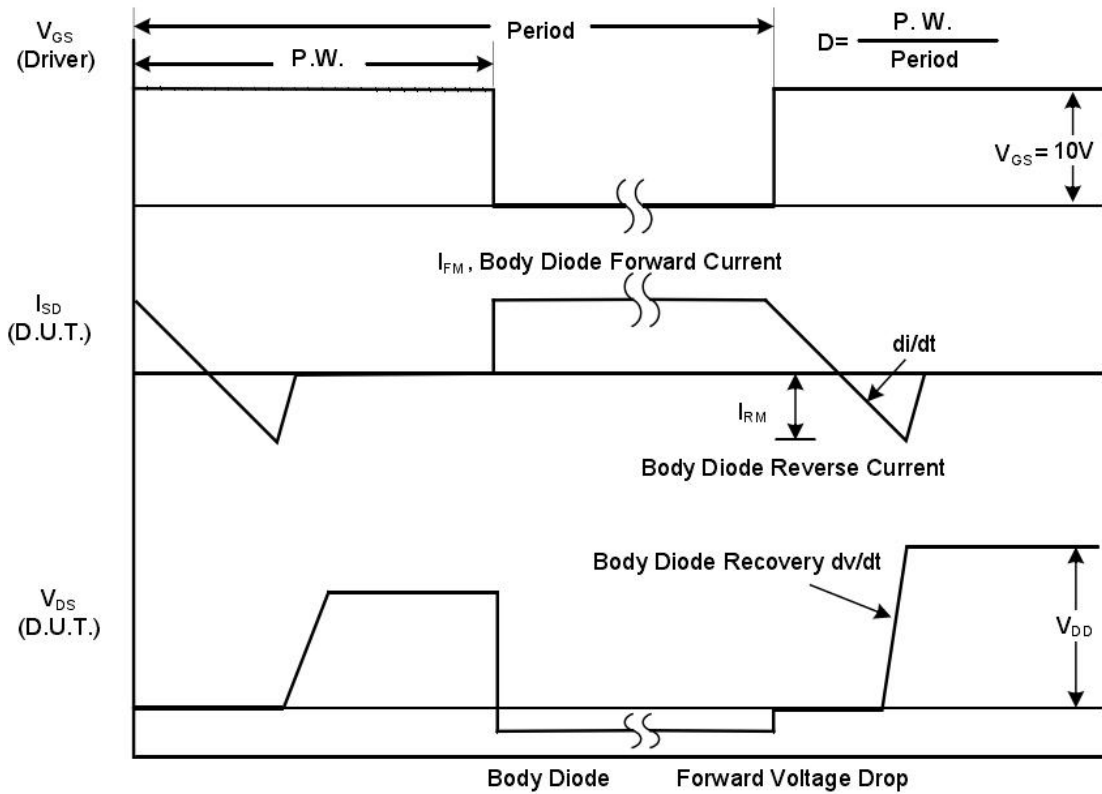

Peak Diode Recovery dv/dt Waveforms

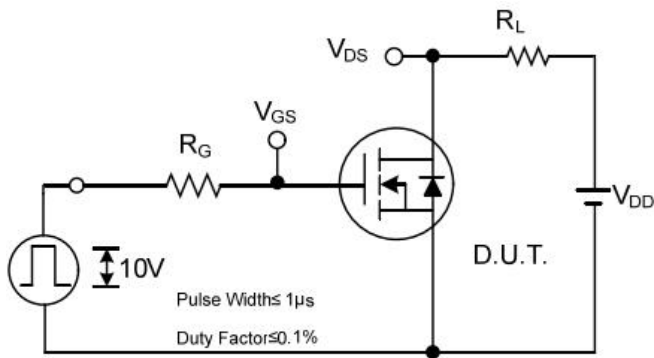

**Switching Test Circuit**

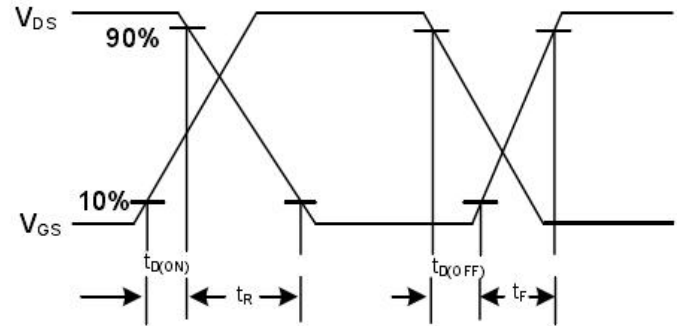

**Switching Waveforms**

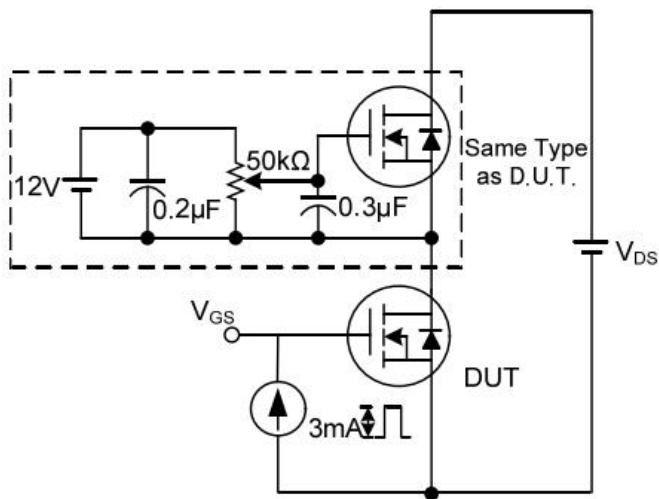

**Gate Charge Test Circuit**

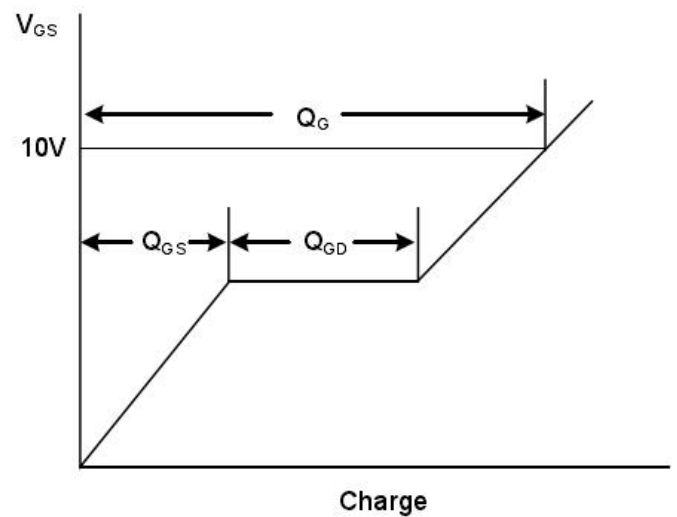

**Gate Charge Waveform**

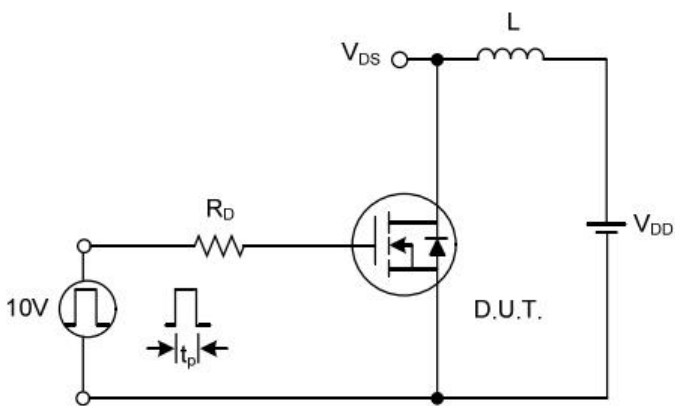

**Unclamped Inductive Switching Test Circuit**

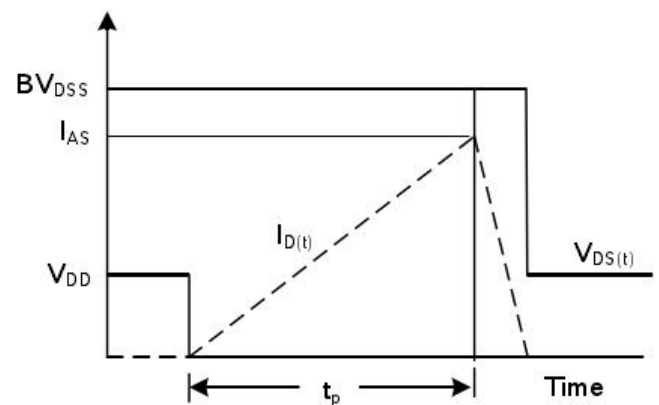

**Unclamped Inductive Switching Waveforms**



## RATING AND CHARACTERISTIC CURVES

Figure.1 Typical Output Characteristics

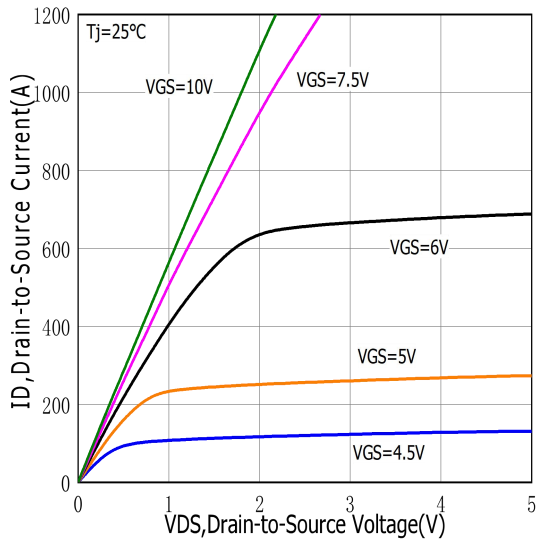

Figure.2 Typical Gate Charge vs Gate to Source Voltage

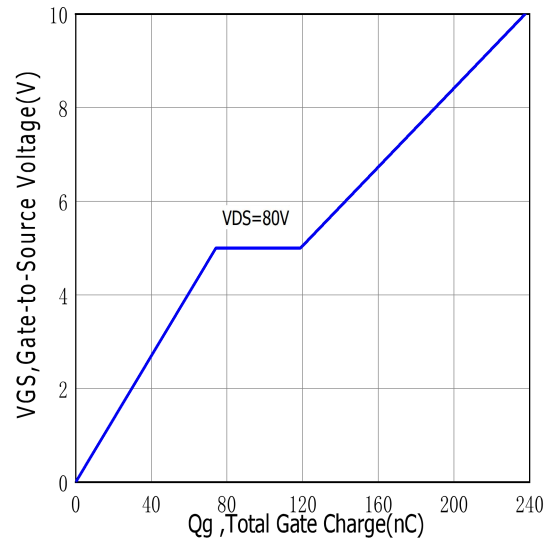

Figure.3 Typical Body Diode Transfer Characteristics

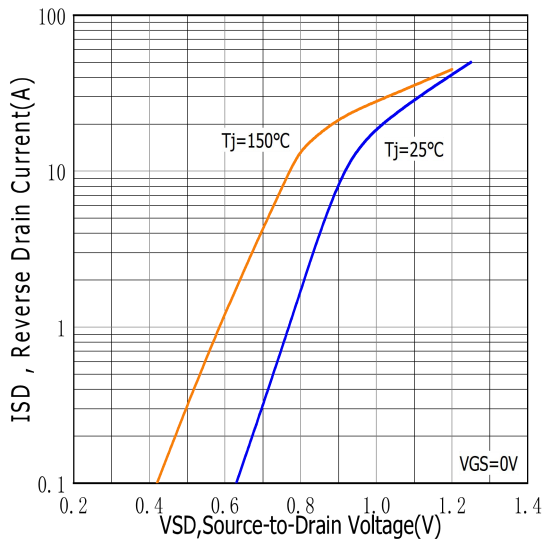
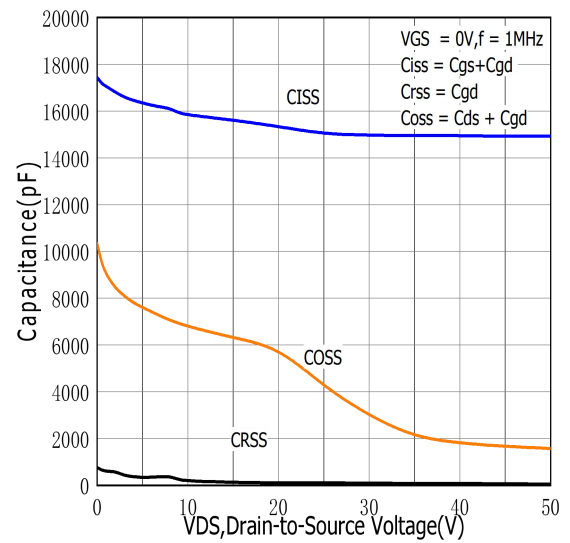
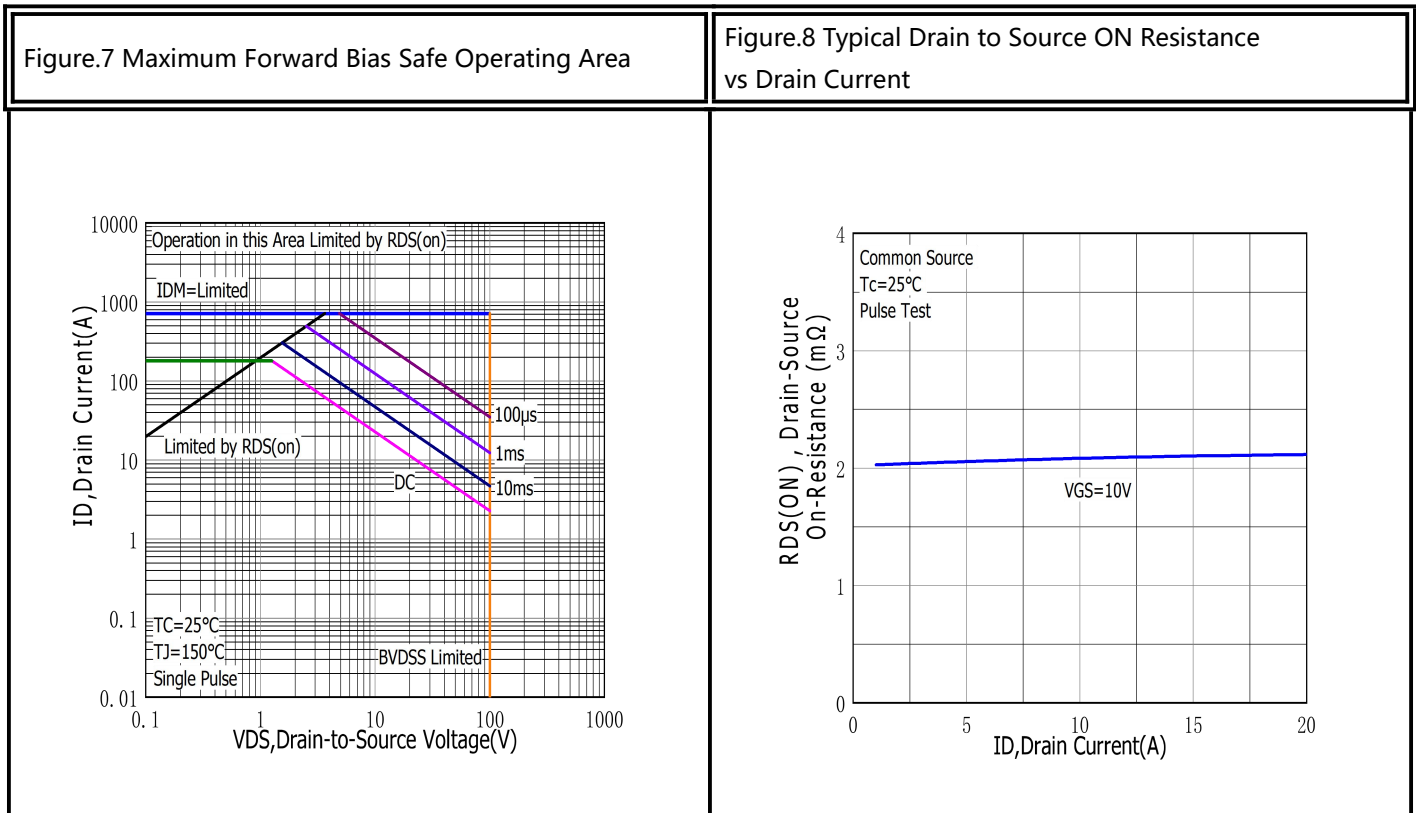
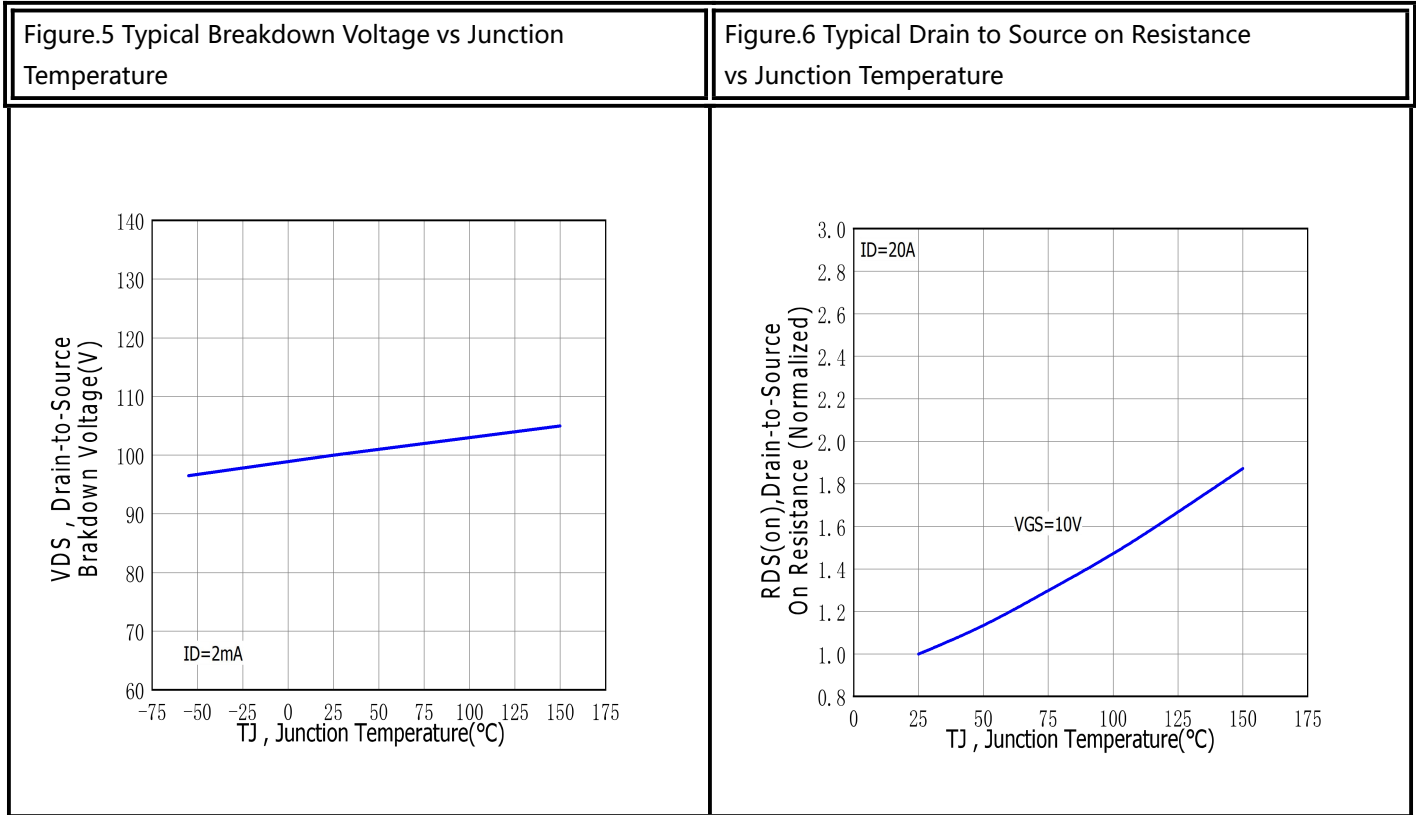

Figure.4 Typical Capacitance vs Drain to Source Voltage





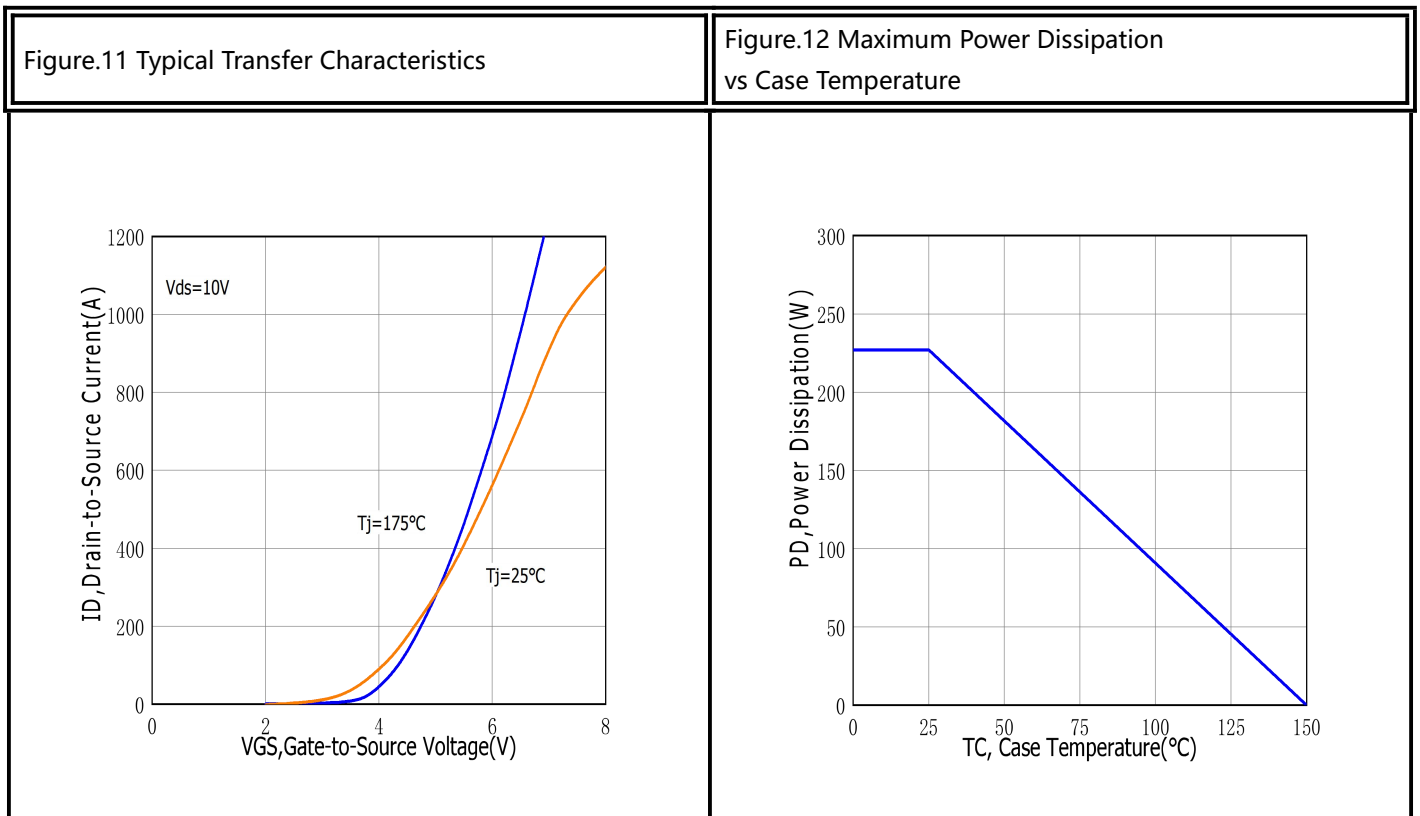
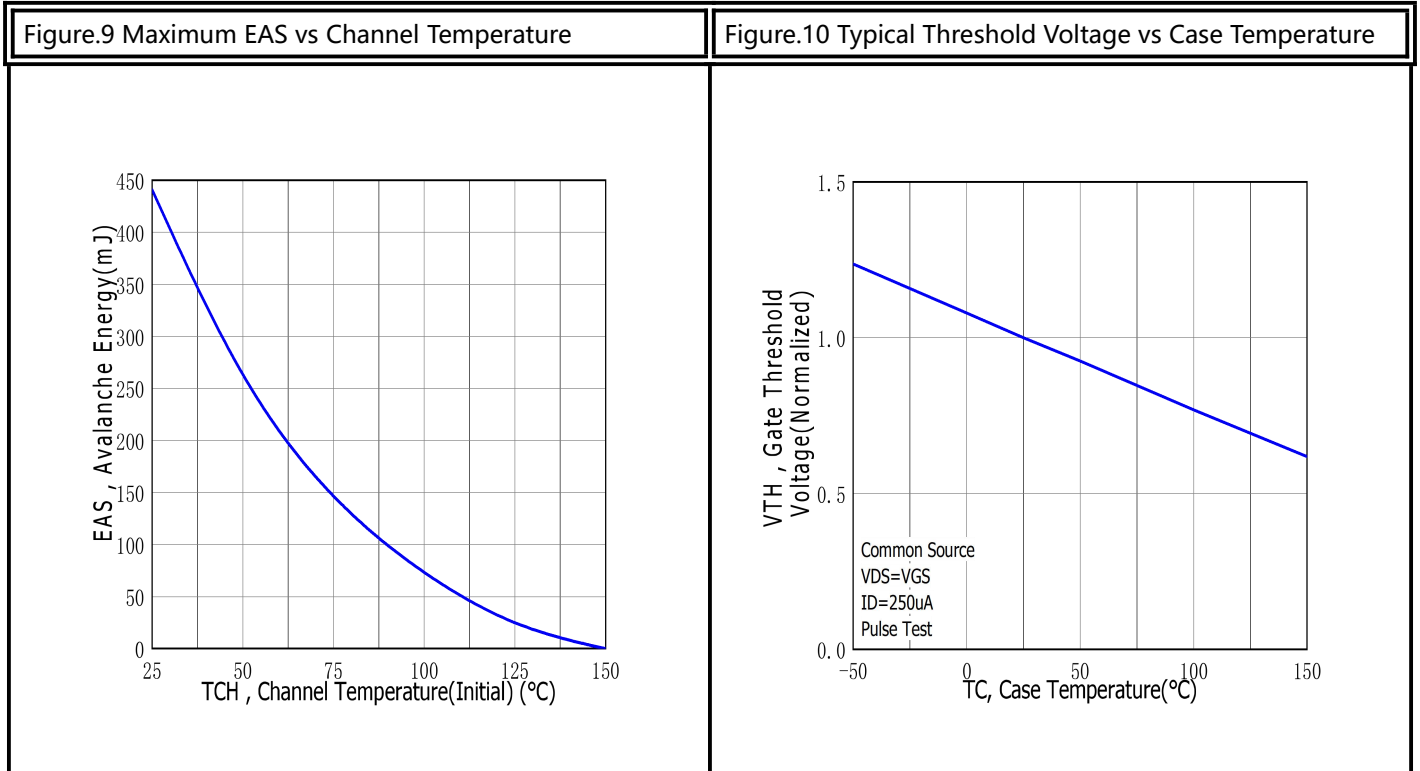
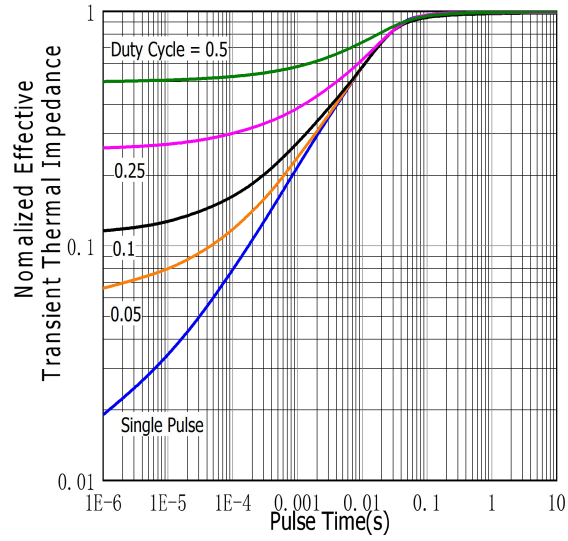

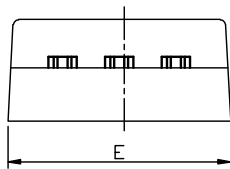
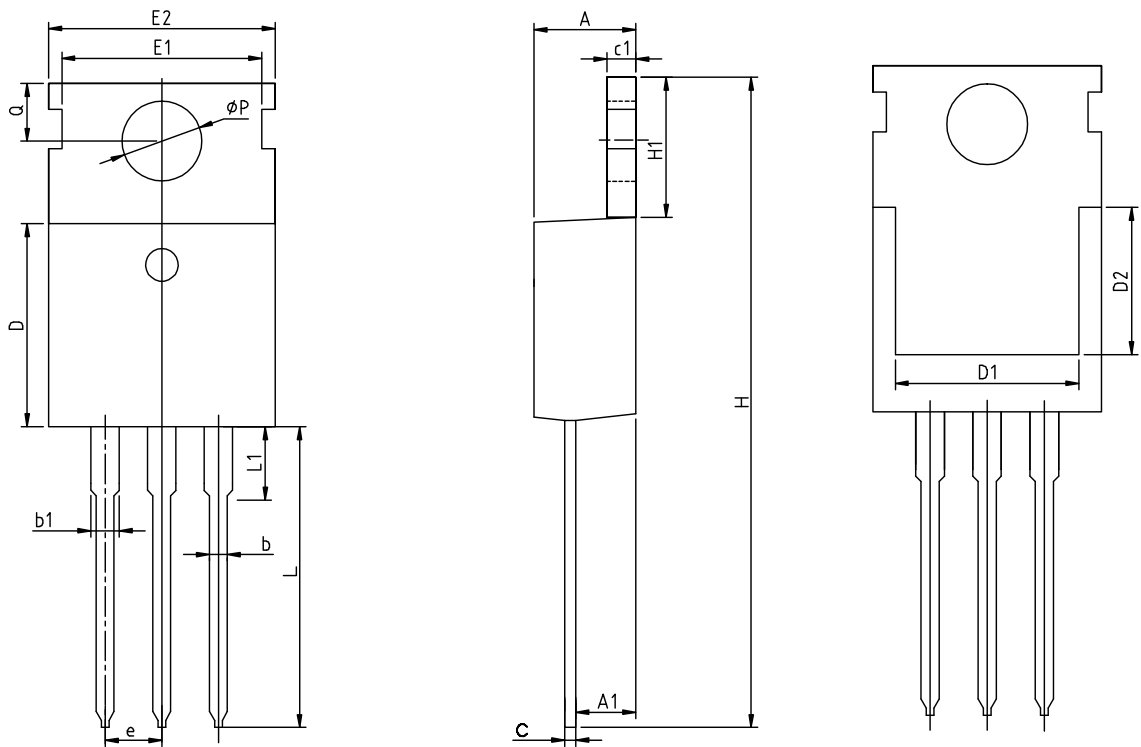



Figure.13 Maximum Effective Thermal Impedance , Junction to Case



## TO-220CB-3L PACKAGE OUTLINE



RECOMMENDED LAND PATTERN

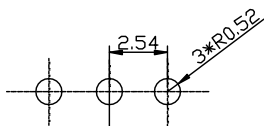

UNIT: mm

	MIN	NOM	MAX
A	4.40	4.60	4.80
A1	2.25	2.40	2.55
b	0.72	0.82	0.92
b1	1.12	1.27	1.42
c	0.40	0.50	0.60
c1	1.20	1.30	1.40
D	8.80	9.10	9.40
D1	7.75	7.95	8.15
D2	6.55	6.75	6.95
e		2.54BSC	
E	9.65	10.00	10.35
E1		8.70	
E2	9.70	10.00	10.30
H	28.70	29.20	29.70
H1	6.25	6.50	6.85
L	13.20	13.50	13.80
L1	2.80	3.10	3.40
Q	2.60	2.80	3.00
$\Phi P$	3.45	3.60	3.75